

Gate Valves [GEN]

Standard: EN 1984

DN 50 ÷ DN 600

PN 16 ÷ PN 160

Distributed by

WAGNER
Armaturen

Wagner Armaturen GmbH

Nikolaus-Otto-Str. 2a

22946 Trittau

www.wagner-armaturen.de

Design

- Casted body and bonnet
- Bolted bonnet (BB)
- Rising stem (RS), outside screw and yoke (OS&Y)
- Wedge may be one-piece flexible, solid or split wedge type

Applications

- Refining, Petrochemical, Chemical, Power plant

Media

- Depending on the gate valve materials: water, steam, gas, oil and oil derivatives and other non aggressive media

Pressure and temperature (table D.1.9)

- Pressure up to 160 bar
- Temperature up to 600 °C

Materials (table D.1.1)

- Carbon, heat resistant alloys and stainless steels

Advantages

- Long service life
- Respect to emission standards
- Easy handling and maintenance
- Stem packing replacement in working conditions

Testing

- Every produced gate valve was tested according to EN 12266

Options

- Electric, hydraulic or pneumatic actuator
- Position indicator
- Extended stem
- Locking device
- Non rising stem and solid wedge
- Hole in the wedge (overpressure safety design)
- Spring loaded stuffing box (SLSB)
- With equalizing pipe
- With bypass Valve
- With equalizing pipe and bypass valves
- Flanges and welding ends according to: ASME, DIN, GOST, etc.
- Other paint finishes are available upon customer's request
- Gate valve complete with counter flanges, bolting and gaskets.

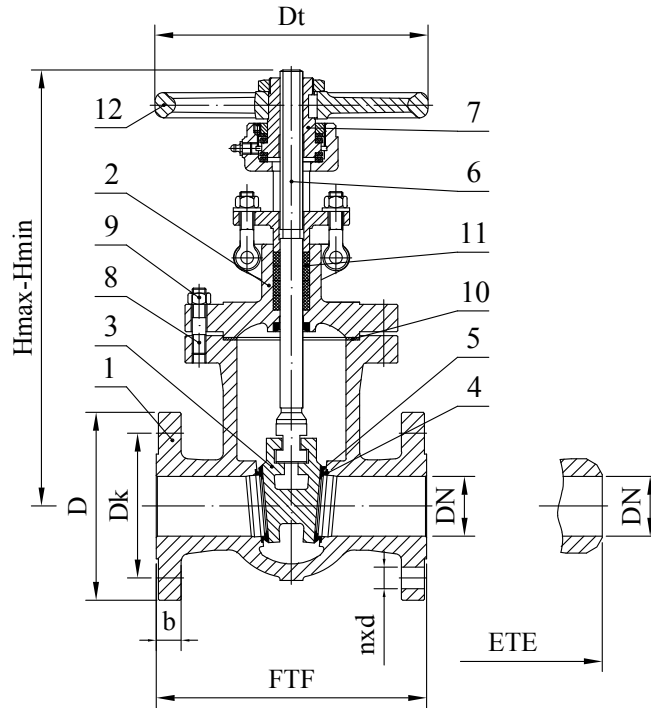

Drawing D.1.1 Parts and dimensions

List of materials

Table D.1.1

Item	Part	Material Group acc. to EN 12516-1					
		3E0	4E0	5E0	6E0	11E0	14E0
		Application					
		up to 400°C	up to 550°C	up to 550°C	up to 600°C	-196°C+600°C	-196°C+600°C
1	Body ⁽¹⁾	1.0619	1.5419	1.7357	1.7379	1.4308	1.4408
2	Bonnet ⁽¹⁾	1.0619	1.5419	1.7357	1.7379	1.4308	1.4408
3	Wedge ⁽¹⁾	1.0619	1.5419	1.7357	1.7379	1.4308	1.4408
4	Body welded on with	13Cr	17Cr (up to 450°C) or Stellite		Basic material or Stellite		
5	Wedge welded on with	13Cr	17Cr (up to 450°C) or Stellite		Basic material or Stellite		
6	Stem	1.4021 / 1.4122				1.4301	1.4571
7	Stem Nut	1.0715 / 1.7225				Cu alloy	
8	Stud Bolts	A193 B7 / 1.7225	A193 B16 / 1.7709			A193 B8 / 1.4301	A193 B8M / 1.4401
9	Nuts	A194 2H / 1.1191	A194 4 / 1.7709			A194 8 / 1.4301	A194 8M / 1.4401
10	Bonnet Gasket	reinforced pure graphite					
11	Stem Packing	graphite with corrosion inhibitor					
12	Handwheel	steel					

⁽¹⁾other materials available according to EN standard

Standards

Table D.1.2

Gate Valves according to EN 1984	PN 16 / PN 25	PN 40 / PN 63 / PN 100 / PN 160
Face-to face dimensions according to	EN 558, Serie 15	EN 558, Serie 26 or Manufacturer standard
Flanged ends according to	EN 1092-1, Tip B1	
End-to-end dimensions according to	EN 12982, Serie 15	EN 12982, Serie 26 or Manufacturer standard
Welding ends according to	EN 12627	

[GEN] Dimensions PN16
Table D.1.3

DN		50	65	80	100	125	150	200	250	300	350	400	500	600
[mm]	FTF / ETE	250	270	280	300	325	350	400	450	500	550	600	700	800
	D	165	185	200	220	250	285	340	405	460	520	580	715	840
	Dk	125	145	160	180	210	240	295	355	410	470	525	650	770
	b	18	18	20	20	22	22	24	26	28	30	32	44	54
	nxd	4x18	(2)x18	8x18	8x18	8x18	8x22	12x22	12x26	12x26	16x26	16x30	20x33	20x36
	Hmax	455	515	555	664	757	945	1133	1318	1560	1720	1910	2325	2868 ⁽⁴⁾
	Hmin	385	431	459	544	622	765	903	1058	1250	1335	1481	1797	2223 ⁽⁴⁾
	Dt	250	250	250	250	315	315	400	500	500	500	630	730	500 ⁽³⁾
kg	FTF	28	37	48	50	79	85	134	245	330	580	590	1000	1650
	ETE	25	29	38	43	69	74	123	212	381	480	510	880	1400

⁽²⁾ 8 holes is preferred however 4 holes may be supplied upon special request by the purchaser.

[GEN] Dimensions PN25
Table D.1.4

DN		50	65	80	100	125	150	200	250	300	350	400	500	600
[mm]	FTF / ETE	250	270	280	300	325	350	400	450	500	550	600	700	800
	D	165	185	200	235	270	300	360	425	485	555	620	730	845
	Dk	125	145	160	190	220	250	310	370	430	490	550	660	770
	b	20	22	24	24	26	28	30	32	34	38	40	48	58
	nxd	4x18	8x18	8x18	8x22	8x26	8x26	12x26	12x30	16x30	16x33	16x36	20x36	20x39
	Hmax	455	515	555	664	757	945	1133	1318	1560	1720	1910	2325	2868 ⁽⁴⁾
	Hmin	385	431	459	544	622	765	903	1058	1250	1335	1481	1797	2223 ⁽⁴⁾
	Dt	250	250	250	250	315	400	400	500	500	500	630	730	500 ⁽³⁾
kg	FTF	29	37	49	68	84	130	193	300	445	580	670	1025	1700
	ETE	22	33	40	57	75	93	164	264	381	530	620	880	1400

[GEN] Dimensions PN40
Table D.1.5

DN		50	65	80	100	125	150	200	250	300	350	400	450	500	600
[mm]	FTF / ETE	250	290	310	350	400	450	550	650	750	850	950	914	1150	1350
	D	165	185	200	235	270	300	375	450	515	580	660	685	755	890
	Dk	125	145	160	190	220	250	320	385	450	510	585	610	670	795
	b	20	22	24	24	26	28	34	38	42	46	50	50	57	72
	nxd	4x18	8x18	8x18	8x22	8x26	8x26	12x30	12x33	16x33	16x36	16x39	20x39	20x42	20x48
	Hmax	470	520	571	671	775	915	1123	1430	1624	1747	1888	2160 ⁽⁴⁾	2284 ⁽⁴⁾	2738 ⁽⁴⁾
	Hmin	395	440	476	551	641	750	907	1125	1292	1372	1481	1690 ⁽⁴⁾	1764 ⁽⁴⁾	2123 ⁽⁴⁾
	Dt	250	250	250	250	400	400	500	500	500	630	730	400 ⁽³⁾	500 ⁽³⁾	630 ⁽³⁾
kg	FTF	34	53	49	77	146	167	267	410	555	860	1200	1420	1820	2200
	ETE	32	49	44	66	103	152	235	374	490	820	1095	1120	1486	1700

[GEN] Dimensions PN63
Table D.1.6

DN		50	65	80	100	125	150	200	250	300	350	400	450	500
[mm]	FTF / ETE	250	290	310	350	400	450	550	650	750	762	950	914	1150
	D	180	205	215	250	295	345	415	470	530	600	670	715	800
	Dk	135	160	170	200	240	280	345	400	460	525	585	630	705
	b	26	26	28	30	34	36	42	46	52	56	60	64	68
	nxd	4x22	8x22	8x22	8x26	8x30	8x33	12x36	12x36	16x36	16x39	16x42	20x42	20x48
	Hmax	455	520	557	631	773	889	1102	1459	1649	1742	1888 ⁽⁴⁾	2160 ⁽⁴⁾	2410 ⁽⁴⁾
	Hmin	385	440	465	520	630	726	875	1146	1307	1362	1481 ⁽⁴⁾	1690 ⁽⁴⁾	1900 ⁽⁴⁾
	Dt	250	250	250	315	400	500	500	630	630	630	500 ⁽³⁾	630 ⁽³⁾	630 ⁽³⁾
kg	FTF	42	53	68	83	152	197	319	643	940	880	1234	1480	2800
	ETE	40	49	61	67	120	166	282	563	813	720	110	1120	2685

[GEN] Dimensions PN100
Table D.1.7

DN		50	65	80	100	125	150	200	250	300	350	400	500
[mm]	FTF / ETE	250	290	310	350	400	450	550	650	750	850	991	1150
	D	195	220	230	265	315	355	430	505	585	655	715	870
	Dk	145	170	180	210	250	290	360	430	500	560	620	760
	b	30	34	36	40	40	44	52	60	68	74	78	94
	nxd	4x26	8x26	8x26	8x30	8x33	12x33	12x36	12x39	16x42	16x48	16x48	20x56
	Hmax	470	520	570	676	775	926	1128	1405	1638	1910 ⁽⁴⁾	2180 ⁽⁴⁾	2410 ⁽⁴⁾
	Hmin	395	440	476	556	641	764	912	1145	1307	1530 ⁽⁴⁾	1750 ⁽⁴⁾	1900 ⁽⁴⁾
	Dt	250	250	250	315	400	500	500	730	730	500 ⁽³⁾	500 ⁽³⁾	630 ⁽³⁾
kg	FTF	44	55	70	110	164	239	419	675	1000	1250	1540	2892
	ETE	40	42	55	92	124	205	328	590	813	846	1020	2685

[GEN] Dimensions PN160
Table D.1.8

DN		50	65	80	100	150	200	250	300
[mm]	FTF / ETE	368	419	390	450	600	750	838	965
	D	195	220	230	265	355	430	515	585
	Dk	145	170	180	210	290	360	430	500
	b	30	34	36	40	40	50	60	68
	nxd	4x26	8x26	8x26	8x30	12x33	12x36	12x42	16x42
	Hmax	540	6583	630	745	976	1164	1448 ⁽⁴⁾	1605 ⁽⁴⁾
	Hmin	466	576	535	626	785	948	1168 ⁽⁴⁾	1305 ⁽⁴⁾
	Dt	315	400	400	400	500	630	500 ⁽³⁾	500 ⁽³⁾
kg	FTF	70	117	101	162	335	596	939	1405
	ETE	51	95	78	131	250	450	716	1100

⁽³⁾ Operated by gearbox

⁽⁴⁾ Height without actuator

Range of application

Table D.1.9

Materials	PN	Pressure (bar)/temperature (°C) ratings according to EN 12516-1																					
		-10	20	50	100	150	200	250	300	350	375	400	425	450	470	475	480	500	510	525	550	575	600
1.0619	16	16,0	16,0	16,0	15,0	14,2	13,4	12,3	11,1	10,4	10,0	9,6											
	25	25,0	25,0	25,0	23,4	22,2	21,0	19,2	17,4	16,2	15,6	15,0											
	40	40,0	40,0	40,0	37,4	35,5	33,6	30,7	27,8	25,9	25,0	24,0											
	63	63,0	63,0	63,0	59,0	55,9	52,9	48,4	43,8	40,8	39,3	37,8											
	100	100,0	100,0	100,0	93,6	88,8	84,0	76,8	69,6	64,8	62,4	60,0											
160	160,0	160,0	160,0	149,8	142,1	134,5	122,9	111,4	103,7	99,9	96,0												
1.5419	16	16,0	16,0	16,0	16,0	15,7	14,6	13,6	12,7	11,9	11,7	11,5	11,1	10,7	10,5	10,5	10,4	7,3	6,3	4,5	2,6		
	25	25,0	25,0	25,0	25,0	24,5	22,8	21,3	19,8	18,6	18,3	18,0	17,3	16,7	16,4	16,4	16,3	11,3	9,9	7,1	4,0		
	40	40,0	40,0	40,0	40,0	39,1	36,5	34,1	31,7	29,8	29,3	28,8	27,7	26,7	26,3	26,2	26,1	18,1	15,8	11,3	6,4		
	63	63,0	63,0	63,0	63,0	61,6	57,5	53,7	49,9	46,9	46,1	45,4	43,7	42,0	41,4	41,3	41,1	28,6	24,9	17,8	10,1		
	100	100,0	100,0	100,0	100,0	97,8	91,2	85,2	79,2	74,4	73,2	72,0	69,4	66,7	65,8	65,5	65,3	45,3	39,5	28,3	16,0		
160	160,0	160,0	160,0	160,0	156,6	146,0	136,4	126,8	119,1	117,2	115,3	111,0	106,8	105,3	104,9	104,5	72,6	63,2	45,2	25,6			
1.7357	16	16,0	16,0	16,0	16,0	16,0	16,0	16,0	16,0	14,9	14,4	13,7	13,1	12,6	12,0	11,8	11,6	10,0	8,9	7,3	4,7		
	25	25,0	25,0	25,0	25,0	25,0	25,0	25,0	25,0	23,3	22,4	21,3	20,4	19,7	18,7	18,5	18,1	15,6	13,9	11,5	7,3		
	40	40,0	40,0	40,0	40,0	40,0	40,0	40,0	40,0	37,3	35,9	4,1	32,7	31,5	29,9	29,5	28,9	25,0	22,3	18,3	11,7		
	63	63,0	63,0	63,0	63,0	63,0	63,0	63,0	63,0	58,7	56,5	53,8	51,4	49,7	47,2	46,5	45,5	39,3	35,1	28,9	18,5		
	100	100,0	100,0	100,0	100,0	100,0	100,0	100,0	100,0	93,1	89,8	85,3	81,6	78,9	74,9	73,9	72,2	62,4	55,8	45,9	29,3		
160	160,0	160,0	160,0	160,0	160,0	160,0	160,0	160,0	149,1	143,7	136,6	130,7	126,2	119,8	118,2	115,6	99,9	89,3	73,4	47,0			
1.7379	16	16,0	16,0	16,0	16,0	16,0	16,0	16,0	15,0	14,5	13,7	13,1	12,6	12,0	11,8	11,6	10,5	10,2	8,6	5,6	5,5	2,4	
	25	25,0	25,0	25,0	25,0	25,0	25,0	25,0	23,5	22,6	21,3	20,4	19,7	18,7	18,5	18,1	16,5	15,9	13,5	8,8	8,6	3,7	
	40	40,0	40,0	40,0	40,0	40,0	40,0	40,0	37,5	36,2	34,1	32,7	31,5	29,9	29,5	28,9	26,3	25,4	21,5	14,1	13,8	6,0	
	63	63,0	63,0	63,0	63,0	63,0	63,0	63,0	59,1	57,0	53,8	51,4	49,7	47,2	46,5	45,5	41,5	40,0	33,9	22,2	21,7	9,4	
	100	100,0	100,0	100,0	100,0	100,0	100,0	100,0	93,8	90,5	85,3	81,6	78,9	74,9	73,9	72,2	65,8	63,5	53,9	35,2	34,4	14,9	
160	160,0	160,0	160,0	160,0	160,0	160,0	160,0	160,0	150,2	144,9	136,6	130,7	126,2	119,8	118,2	115,6	105,3	101,7	86,2	56,3	55,1	23,9	
1.4308	16	16,0	16,0	16,0	14,8	13,0	11,2	10,5	9,9	9,1	8,9	8,7	8,5	8,2	8,1	8,1	8,0	7,9	7,8	7,3	7,1	6,4	5,0
	25	25,0	25,0	25,0	23,1	20,3	17,5	16,5	15,4	14,3	13,9	13,6	13,2	12,9	12,7	12,6	12,5	12,3	12,2	11,4	11,1	10,0	7,9
	40	40,0	40,0	40,0	37,0	32,5	28,0	26,3	24,6	22,8	22,3	21,7	21,2	20,6	20,3	20,2	20,1	19,7	19,5	18,2	17,7	16,0	12,6
	63	63,0	63,0	63,0	58,2	51,2	44,1	41,5	38,8	36,0	35,1	34,2	33,3	32,5	31,9	31,8	31,6	31,0	30,7	28,7	27,9	25,2	19,8
	100	100,0	100,0	100,0	92,4	81,2	70,0	65,8	61,6	57,1	55,7	54,3	52,9	51,5	50,6	50,4	50,2	49,3	48,7	45,6	44,3	40,0	31,5
160	160,0	160,0	160,0	147,9	130,0	112,1	105,3	98,6	91,4	89,2	87,0	84,7	82,5	81,0	80,7	80,3	78,9	78,0	73,0	70,9	64,0	50,4	
1.4408	16	16,0	16,0	16,0	15,2	13,7	12,1	11,2	10,3	9,9	9,6	9,4	9,2	9,1	9,0	9,0	8,9	8,9	8,8	8,4	8,3	7,0	5,8
	25	25,0	25,0	25,0	23,8	21,4	18,9	17,5	16,1	15,4	15,1	14,7	14,4	14,1	14,0	14,0	13,9	13,8	13,1	12,9	10,9	9,1	
	40	40,0	40,0	40,0	38,1	34,2	30,2	28,0	25,8	24,6	24,1	23,5	23,0	22,6	22,4	22,4	22,2	22,1	20,9	20,7	17,5	14,5	
	63	63,0	63,0	63,0	60,0	53,8	47,6	44,1	40,6	38,8	37,9	37,0	36,2	35,6	35,4	35,3	35,2	34,9	34,8	32,9	32,6	27,6	22,8
	100	100,0	100,0	100,0	95,2	85,4	75,6	70,0	64,4	61,6	60,2	58,8	57,4	56,6	56,1	56,0	55,9	55,4	55,2	52,3	51,7	43,7	36,3
160	160,0	160,0	160,0	152,4	136,7	121,0	112,1	103,1	98,6	96,4	94,1	91,9	90,5	89,8	89,6	89,5	88,7	88,4	83,7	82,8	70,0	58,1	

Optional execution



Elastic wedge

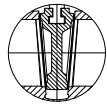

Solid wedge

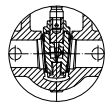

Split wedge

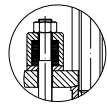

Spring loaded stuffing box (SLSB)

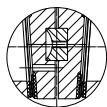

With hole in the wedge

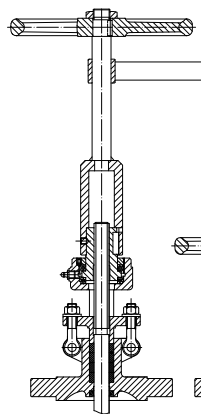

Extended stem

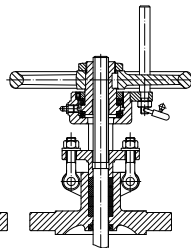

Locking device

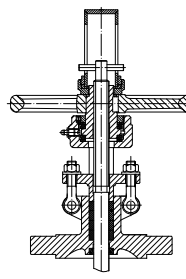

Position indicator

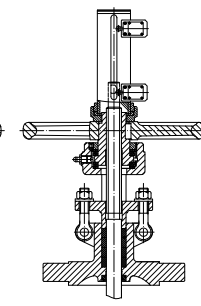

Limit switches

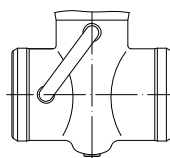

With equalizing pipe

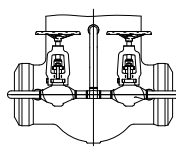

With equalizing pipe and bypass valves

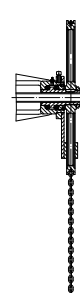

Operated with chain

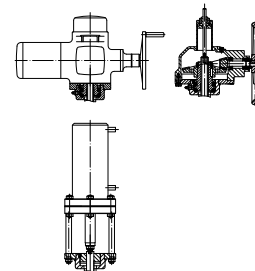

Operated by electric, pneumatic or hydraulic actuator or by gearbox

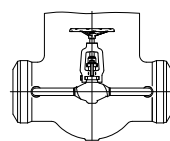

With bypass valve